

# GALEX

## Galaxy Evolution Explorer



This image of the Southern Pinwheel Galaxy, or M83, was taken in ultraviolet light by the Galaxy Evolution Explorer. Ultraviolet light traces populations of young stars. The image shows that new stars are forming at up to 140,000 light-years from the center of the galaxy. Taken at scheduled intervals between March 15 and May 20, 2007, this is one of the longest exposure images ever made of a nearby galaxy (at 15 million light-years away).

New stars in the far-flung arms of the pinwheel



# GALEX: The Galaxy Evolution Explorer

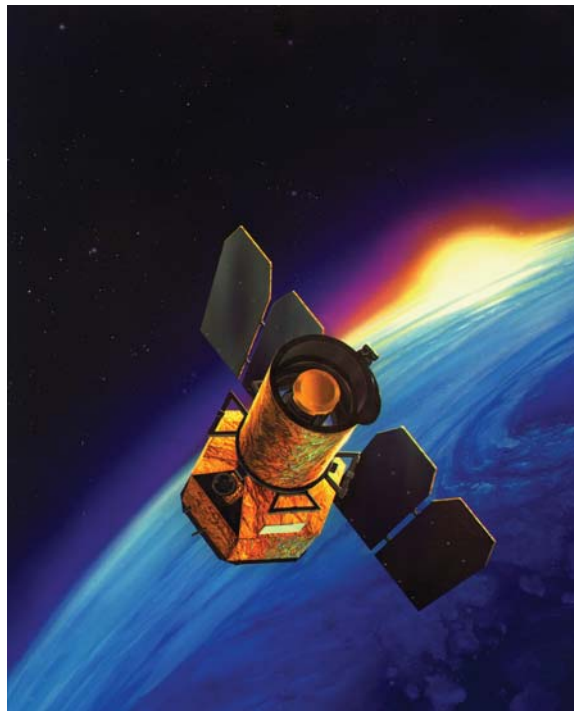

Galaxy Evolution Explorer has been orbiting Earth since 2003. GALEX observes galaxies in **ultraviolet** (UV) light. Because Earth's atmosphere blocks most UV light, GALEX must be above the atmosphere.

GALEX is looking at tens of millions of galaxies spanning much of the universe. A **galaxy** is a grouping of stars, gas, dust, planets, moons, and various strange objects such as black holes all held together by gravity. All but a few stars in the universe live in galaxies. Our Sun is just one of at least 200 billion stars in our own Milky Way Galaxy. The entire universe probably contains over 100 billion galaxies.

Stars, planets, galaxies, clouds of dust and gas, and other matter in space are sending out energy all the time. This energy, called **electromagnetic energy**, travels in **waves**. Like waves traveling through the ocean, electromagnetic waves can be very long, very short, or anything in between.

Therefore, the light we see from the Sun and other stars—the visible light—tells only a small part of the story of the stars. To get the complete picture, we must extend our vision to include other wavelengths or energies of light. That is why scientists and engineers have invented different kinds of telescopes. For example, we have special telescopes for the long radio waves; special telescopes for the infrared waves that we cannot see but rather feel as heat; and we have special telescopes such as GALEX for detecting invisible ultraviolet waves.

GALEX detects the UV light coming from nearly the farthest parts of the universe. Some of this light is almost two-thirds as old as the universe itself, having taken billions of years to reach us from the galaxies that were its source.

GALEX is especially good at finding star nurseries—places where new stars are forming inside galaxies. GALEX can see these hot, baby stars well, because they shine brightly in ultraviolet light. And because GALEX does not see visible light, it is not confused by the larger number of older stars. By studying galaxies near and far away, especially those that glow strongly in ultraviolet, scientists can understand better where and how stars are formed, how galaxies come to be, and how galaxies change over cosmic time.

GALEX can detect stars and galaxies that are about 40 million times fainter than ones we can see with our unaided eyes from even the darkest skies here on Earth. GALEX is the first mission to map most of the sky in UV light at a great enough distance to survey galaxies outside our own galaxy. Its all-sky map will also help astronomers find the most interesting looking galaxies for future study in detail using other telescopes.

The GALEX mission is managed by the Jet Propulsion Laboratory and the California Institute of Technology. To learn more about the Galaxy Evolution Explorer and see more of its images, visit [www.galex.caltech.edu](http://www.galex.caltech.edu).

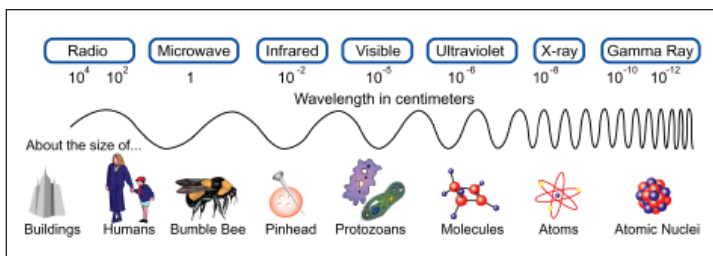

*The electromagnetic spectrum. Electromagnetic energy includes wavelengths from more than 100 meters (longer than a football field) to less than the diameter of an atom's nucleus.*

*The activity on this poster meets the following Standards for Technological Literacy as promulgated by the International Technology Education Association:*

Standard	Expectations for Grades 6-8
#1. Understand the characteristics and scope of technology.	H. Learn that technology is closely linked to creativity, which has resulted in innovation.
#3. Understand relationships among technologies and connections between technology and other fields.	F. Learn that knowledge from other fields affects development of products and systems.
#8. Understand attributes of design.	F. Learn that there is no perfect design.
	G. Learn that requirements for design include criteria and constraints.

# About the Southern Pinwheel Galaxy Image

The Southern Pinwheel Galaxy, or M83, is shown in ultraviolet light on this poster. The Galaxy Evolution Explorer spacecraft took this picture of M83 at intervals between March 15 and May 20, for a total exposure time of 3 hours 42 minutes. In fact, it is one of the “deepest,” or longest-exposure, images of a nearby galaxy ever made in ultraviolet light.

Young stars burn brightly in ultraviolet. This deep view shows clusters of young stars, even in the very remote reaches of the galaxy, up to 140,000 light-years from its core. At this distance, the raw material for making stars is nearly all hydrogen. Previous generations of stars have not “seeded” this remote area of the galaxy with heavier elements that must be forged inside the stars. Therefore, stars at this distance from the core of the galaxy are highly unlikely to contain the necessary heavier elements (such as carbon, nitrogen, oxygen, and iron), for rocky, wet, life-sustaining planets to have formed.

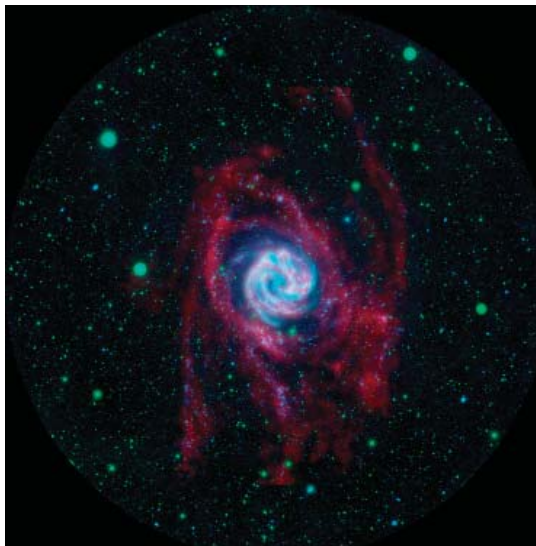

*This image is also M83. It is a GALEX ultraviolet image with an overlay of a radio wavelength image. The radio image shows the extensive clouds of hydrogen (the red streamers) that extend far from the galaxy’s core and provide the raw material for the new stars revealed in the GALEX image. (Radio image from National Science Foundation’s Very Large Array in New Mexico.)*

The Pinwheel Galaxy is 15 million light-years away in the southern constellation Hydra. In this image, near-ultraviolet light (or longer-wavelength ultraviolet light) is represented by yellow and far-ultraviolet light is blue.

## How does GALEX work?

The Galaxy Evolution Explorer detects ultraviolet light that our eyes cannot see. But even if our eyes could

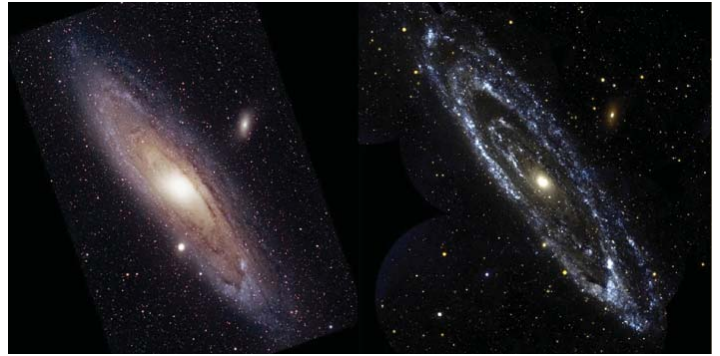

*The Andromeda Galaxy (or M31) is the nearest large galaxy to our own Milky Way Galaxy. On the left is Andromeda in visible light and on the right a GALEX ultraviolet image of Andromeda. The star-forming regions in the spiral arms are quite clumpy compared to the vast regions of old stars. (Visible light image courtesy of John Gleason.)*

see this wavelength of light, we still could not see most of the objects that this galactic explorer sees. The galaxies are just too far away and too faint. Are the ultraviolet detectors in Galaxy Evolution Explorer really that sensitive? No. The other part of how this and other deep space telescopes work is their long exposure times.

Although users of today’s automated digital cameras don’t have to think about such things, photography still depends upon three factors.

1. How **sensitive** is the recording medium to light?
2. How **large** is the opening in the camera that lets in the light?
3. How **much time** is the medium exposed to the light?

Even in a very dark environment where our eyes see almost nothing, we may be able to record an image using the right photographic techniques.

As for the Galaxy Evolution Explorer, the ultraviolet-light-sensitive medium for this telescope, as well as for most digital cameras, is a charge-coupled device, or CCD. A CCD converts light into electrical charges. Since electrical charges are the basic language elements of computers, the image is thus stored.

To see deeper and deeper into space and detect extremely faint objects at billions of light-years away, GALEX must leave its aperture open for many hours. The few photons (particles of light) coming from that distant part of the universe finally, after hours and hours, build up enough charge on the CCD to be detectable as an image of their source. And thus, we see deeply into the cosmos.

# Make a Pinhole Camera

Many GALEX images have exposure times of several hours. GALEX is not only “seeing” a wavelength of light that is invisible to our eyes, but it is also seeing light that is much too dim to register on even its sensitive detectors without exposing them for a very long time. So GALEX’s images are pictures of light recorded over time, thus revealing information that would otherwise be unknowable.

On Earth, using ordinary visible light, we can also create a single image of light recorded over time. Of course a movie or video is light recorded over time, but it is a series of instantaneous snapshots, rather than light and time both recorded on the same medium.

A pinhole camera, which is simple to make out of ordinary materials and using ordinary photographic film, can be placed anywhere and left for several minutes to record whatever photons enter it. Like GALEX, it can be placed in dim light or nearly in the dark, and, if left open long enough, will record an impression of all that goes on in its field of view.

## How does a pinhole camera work?

A pinhole camera is a light-proof box. Light enters the box through a tiny pinhole on one side and strikes the opposite wall of the box, where light-sensitive paper or film (or even a CCD) records an image. The recorded image is upside down (as in all cameras) and focused because the light rays—which travel in straight lines—do not cross each other inside the box.

A pinhole camera is the opposite of “high-tech.” In that way it is very unlike GALEX. However, it uses some of the same basic principles. It is fun at times to go back to the basics and make something with our own hands that we can understand and use creatively.

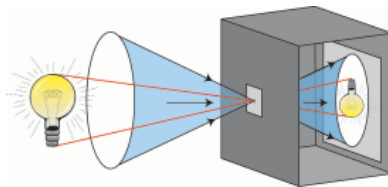

## How to Make a Pinhole Camera

In this activity, you will make your own pinhole camera, and discover its creative possibilities.

### Tools you will need

- Bottle opener
- X-acto® knife or mini-utility knife (with new blade), or small, sharp scissors
- Single hole punch (optional)
- Push pin or needle (with “perfect” point)
- Straight edge with metal edge
- Ballpoint pen (ink color other than black is best)



*A mighty oak.*

### Materials

- Cardboard cereal box (single layer, flattened)
- Scotch® tape (*not* the removable kind)
- Black electrical tape
- Disposable aluminum pie tin (any size)
- 35-mm color print film, ISO 200, 24 or 36 exposures
- Empty film canister, with spool (*not* the plastic container with the snap-off cap, but the metal canister that goes inside the camera. May be available free from a “1-hour Photo” facility)
- 4-inch piece of old 35-mm film, developed (negative strip) or not
- Popsicle® stick, cut in half

### Read these important instructions first!

1. Photocopy pattern page at exact size. Do not reduce or enlarge the pattern. The camera is designed to exactly fit the 35-mm film canisters.
2. Scotch-tape uncut page of pattern pieces to non-printed side of cardboard. (If page does not fit on your box without pattern pieces laying on cereal box folds, cut the page apart above the “film chamber” piece, and lay that piece on the other half of the box.) Using straightedge and ballpoint pen, score all fold lines. Press hard! Red or blue pen will help you see which lines you have already scored.
3. Using X-acto knife, first cut out the holes in the camera pieces. When you cut the round holes for film spools, do not cut them too big or you will create light leaks. If you do not have an X-acto knife, you can first cut out the camera body with scissors, then use a single hole punch to start the spool holes. Insert progressively fatter pens to gently enlarge the openings to the correct size for the film spools to fit tightly. To make straight cuts, use the straightedge to guide the knife. Hold knife vertically. Don’t press too hard, but go over the cuts two or three times to get through the cardboard.
4. Fold pieces on score lines and assemble as shown.



### Step 1: Reversed film canister

Using bottle opener, carefully pop off one side of an old film canister. Work gently and slowly around the edge of the cap, prying only slightly each time until the cap is released from the sides of the canister.

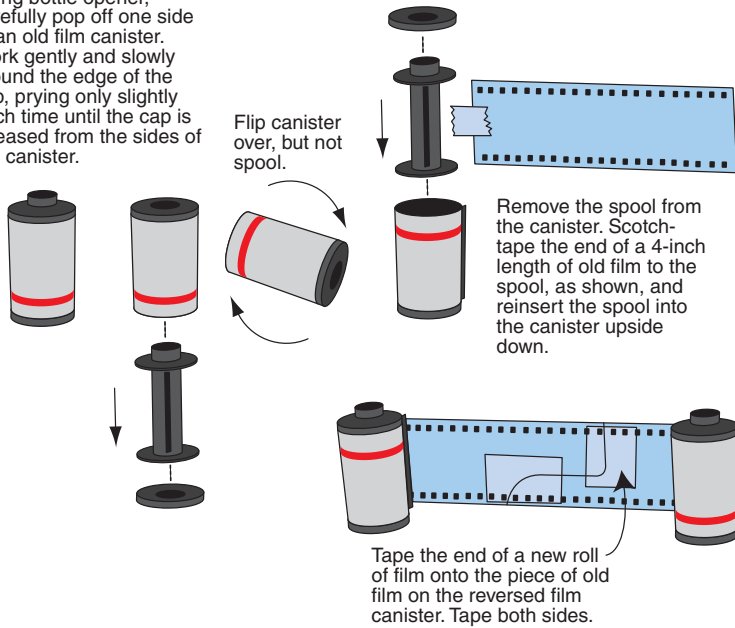

### Step 2: Shutter

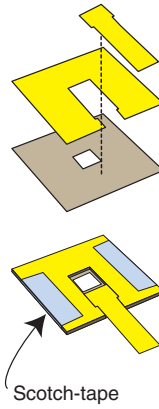

### Step 3: Pinhole



Using a circular motion, carefully push just the tip of a push-pin or needle into a small piece of thin aluminum. The pinhole should be very, very small!

### Step 4: Film chamber

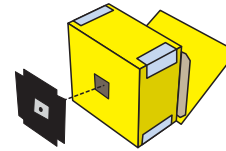
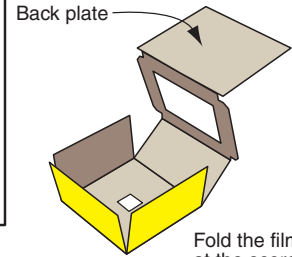

Except for the back plate, tape the film chamber together with Scotch tape, then light-proof it with black electrical tape. Put it up to the light and make sure no light comes through the seams.

### Step 5: Camera body

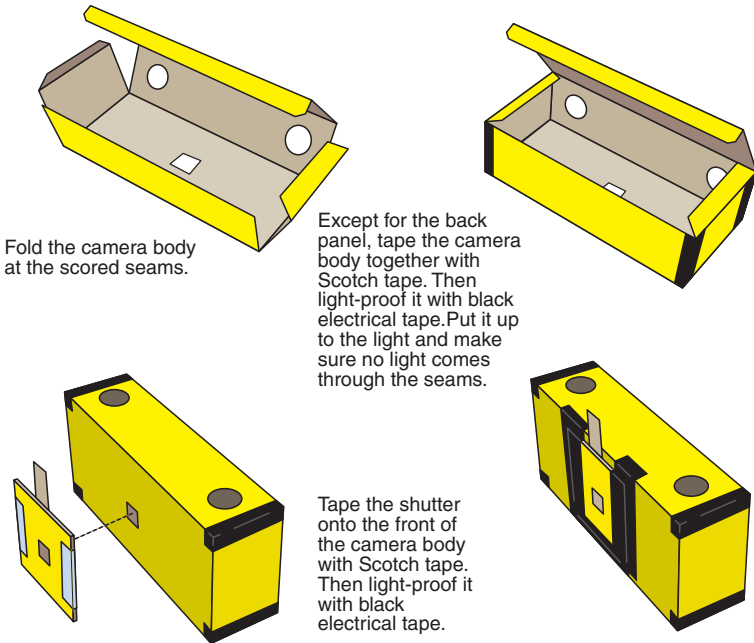

Tape the piece of aluminum containing the pinhole onto the front of the film chamber with black electrical tape, centering it over hole.

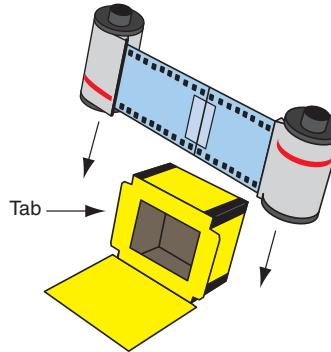
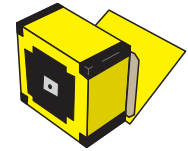

### Step 6: Put it all together

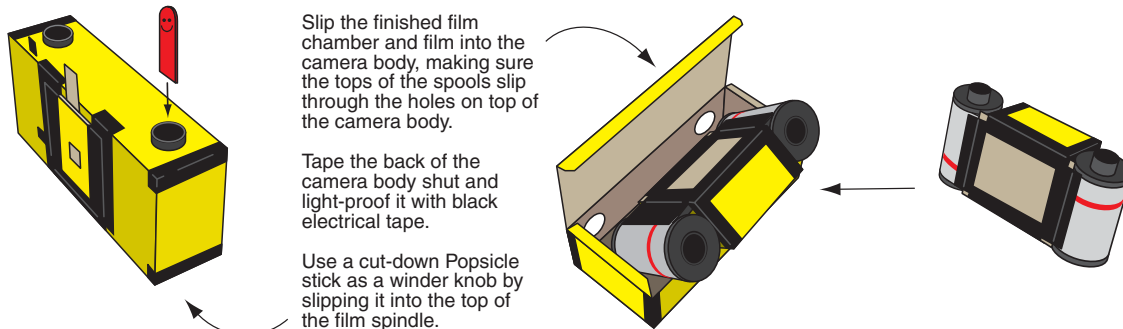

# Cereal Box Pinhole Camera Plans

Print or copy at 100%. Discard all grey areas.

Tape this exposure guide to the back of your camera

Sunny: 1 to 2 seconds  
Cloudy: 5 to 10 seconds  
Indoors: 1 to 3 minutes  
Night: 10 to 15 minutes  
Wind film a full turn after every shot.

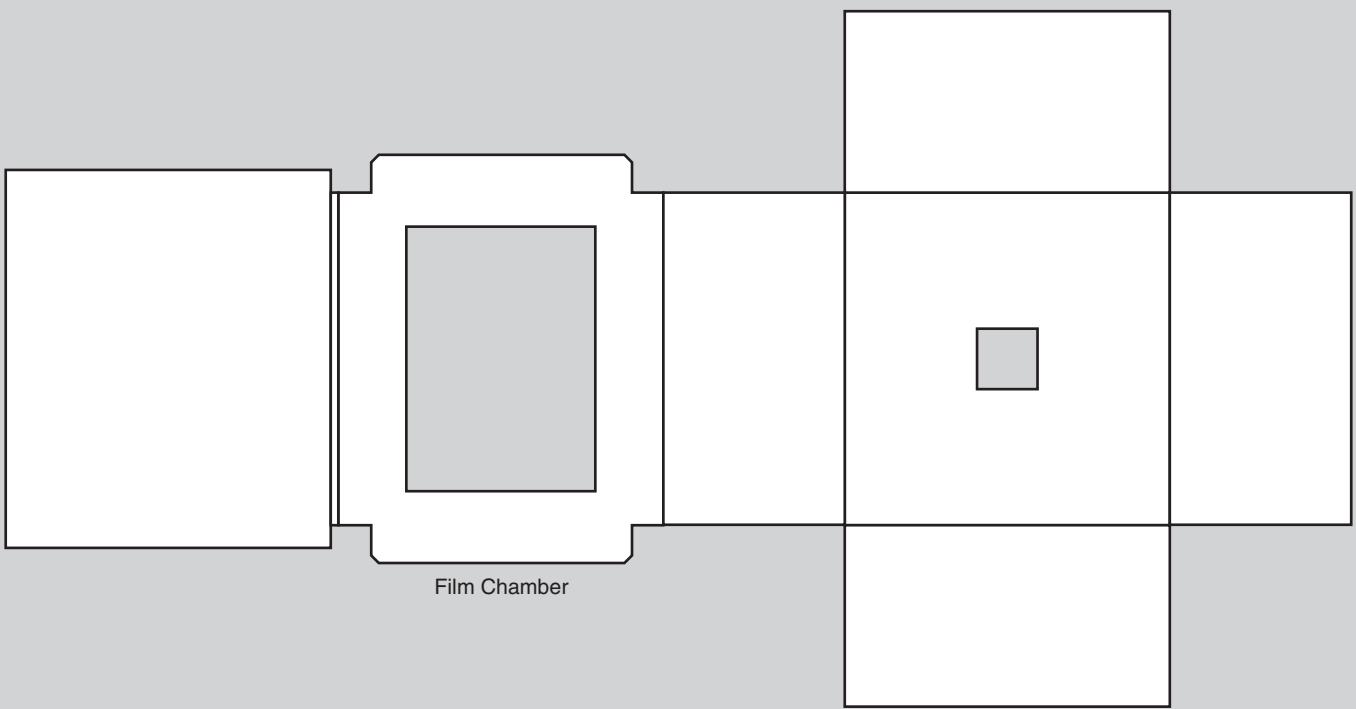
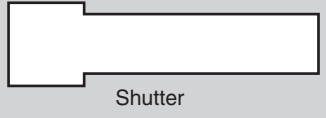
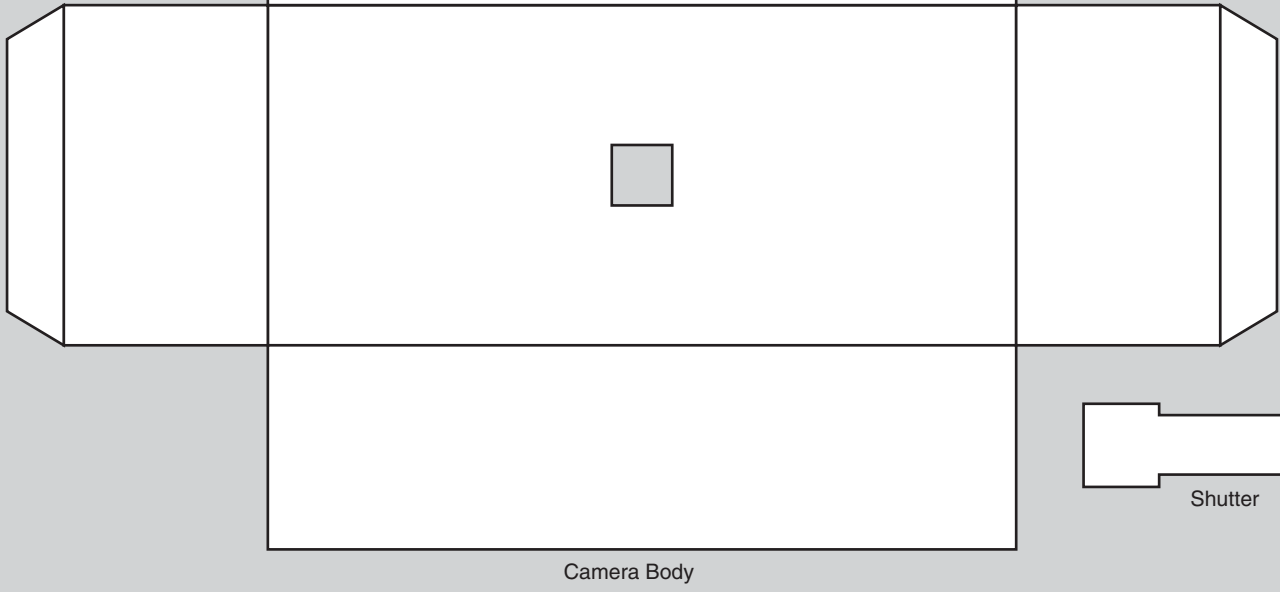
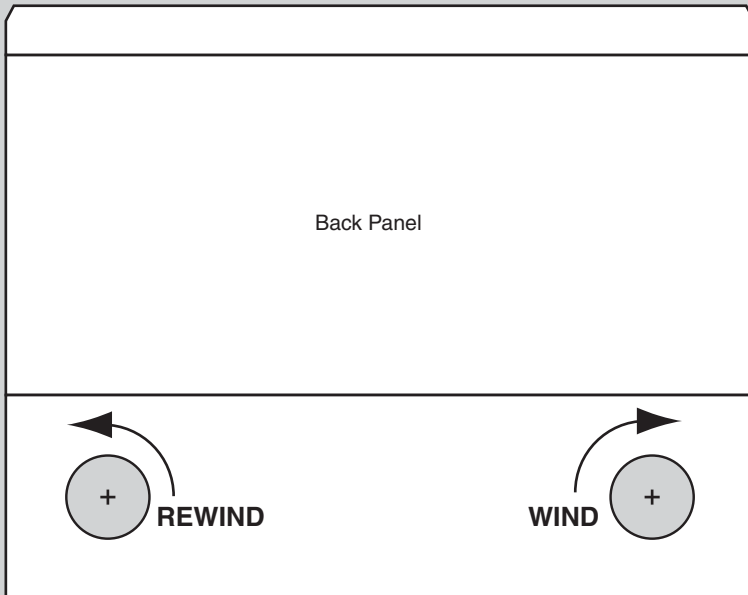

## Taking pictures

Consult the exposure guide that you taped to the back of the camera. Because of the long (1 second to 15 minutes or more) exposure times needed, it's best to set the camera on a solid surface so it won't move during exposures. Pull the shutter tab up to expose film, and push it back down at the end of the desired exposure time. Try not to jiggle the camera when you open and close the shutter.

**Don't forget to advance the film!** Turn the winder stick one complete 360° turn right after every picture you take.

Photos taken with a pinhole camera are different from other photos. They are usually a little fuzzy. However, all parts of the image will be equally in focus, which may give the image a soft, ethereal quality.

Keep a record of exposure times while taking pictures for the first roll or two of film to help you learn the idiosyncrasies of your camera.

## Unloading film from camera

- When you get to the end of the roll, you will feel resistance in the winder stick. Switch the stick to the new film spool and rewind the film back into its canister. Stop when you feel resistance. Your exposed film is safely back in its light-proof canister.
- Carefully remove the tape sealing the back of the camera, and remove the film chamber. Remove the tape from the back plate and film canisters and slip the tabs out of the canisters.
- Remove the tape splicing the new film to the piece of old film taped to the reversed film canister. Use the Popsicle stick to wind the end of the new film into its canister.
- Have film processed and printed by a "1-hour Photo" or similar service. Be sure to tell the technician that the film is from a homemade pinhole camera, and warn them that gaps between the exposed areas will vary. If your prints come back cut off in the wrong places or if unexposed areas of the film are printed, ask them to print them again correctly at no charge.

## Types of pictures to try

- Indoors, up close to small, intricate objects, see how much detail you can record.
- Take multiple photos of the same object at varying distances (making note of the distances), and see how the field of view is affected (that is, wide angle or narrow angle view).
- Take pictures outside in sun and in shade, or on a cloudy day.
- Try capturing the night, outside, on a busy street with automobile traffic passing by. You may need exposure times of 10 minutes or more.



*Night drive.*

- Take a 10-15 minute night ride in the car on city streets. Tape the camera to the car's dashboard. You will get a true recording of light and time!
- Make a portrait of yourself or someone else, in good light so your subject doesn't have to hold still too long. Try playing around with movement during the exposure—like having the subject move his or her head to appear to have two heads!
- Search for Web sites on "pinhole photography" to see photo galleries that may give you more ideas.

## Discussion questions

1. How does the Galaxy Evolution Explorer take images of very faint and faraway objects?
2. Why does a pinhole camera not need a lens?
3. Why are the needed exposure times for photos using a pinhole camera usually longer than for a lens camera?
4. What would happen if the pinhole in the camera were too large?
5. What might happen if the pinhole in the camera were not round?
6. How would the focus of the photos be affected if you could make the pinhole even smaller?
7. How would the exposure time for the photos be affected if you could make the pinhole even smaller?
8. Do you think the size of the box matters when making a pinhole camera?
9. Why is the image recorded on the film inverted in a camera?
10. Do the photos from your pinhole camera express a view of the world a little different from sharp, "high-tech" photos?

*This article was written by Diane Fisher and Alexander Novati. Ms. Fisher is writer of The Space Place website at [spaceplace.nasa.gov](http://spaceplace.nasa.gov). Mr. Novati is designer and illustrator of The Space Place. The article was provided through the courtesy of the Jet Propulsion Laboratory, California Institute of Technology, under a contract with the National Aeronautics and Space Administration.*